



GM 2020 2500 3” Upper Control Arm Kit

Thank you for choosing Rough Country for your suspension needs.

Rough Country recommends a certified technician install this system. In addition to these instructions, professional knowledge of disassemble/reassembly procedures as well as post installation checks must be known. Attempts to install this system without this knowledge and expertise may jeopardize the integrity and/or operating safety of the vehicle.

Please read instructions before beginning installation. Check the kit hardware against the parts list on the rear cover of these instructions. Be sure you have all needed parts and know where they go. Also please review tools needed list and make sure you have needed tools.

PRODUCT USE INFORMATION

▲ WARNING As a general rule, the taller a vehicle is, the easier it will roll. Seat belts and shoulder harnesses should be worn at all times. Avoid situations where a side rollover may occur. Generally, braking performance and capability are decreased when larger/heavier tires and wheels are used. Take this into consideration while driving. Do not add, alter, or fabricate any factory or after-market parts to increase vehicle height over the intended height of the Rough Country product purchased. Mixing component brands is not recommended.

Rough Country makes no claims regarding lifting devices and excludes any and all implied claims. We will not be responsible for any product that is altered. If question exist we will be happy to answer any questions concerning the design, function, and correct use of our products.

▲ NOTICE This kit is packaged as a leveling kit—raising the front 3” and the back 1.5”.

This suspension system was developed using a 295/70-18 tire with factory aluminum 18” wheels. **Note** if wider tires are used, offset wheels will be required and trimming may be required.

NOTICE TO DEALER AND VEHICLE OWNER

▲ NOTICE Any vehicle equipped with any Rough Country product should have a “Warning to Driver” decal installed on the inside of the windshield or on the vehicle’s dash. The decal should act as a constant reminder for whoever is operating the vehicle.

Torque Specs:

Size	Grade 5	Grade 8	Size	Class 8.8	Class 10.9
5/16”	15 ft/lbs	20ft/lbs	6MM	5ft/lbs	9ft/lbs
3/8”	30 ft/lbs	35ft/lbs	8MM	18ft/lbs	23ft/lbs
7/16”	45 ft/lbs	60ft/lbs	10MM	32ft/lbs	45ft/lbs
1/2”	65 ft/lbs	90ft/lbs	12MM	55ft/lbs	75ft/lbs
9/16”	95 ft/lbs	130ft/lbs	14MM	85ft/lbs	120ft/lbs
5/8”	135ft/lbs	175ft/lbs	16MM	130ft/lbs	165ft/lbs
3/4”	185ft/lbs	280ft/lbs	18MM	170ft/lbs	240ft/lbs



1958

Driver Side Control Arm x1
Pass Side Control Arm x1

1958BOX2

1958BAG1

1959BAG6

1958BAG

1959BAG9

5/8 BAG

660744 Rear N3 Shocks x2

660795 Front N3 Shocks x2

5/8" x 12" U-bolts x4

Front Skid Plate Bracket x2

Sway Bar Brackets x2

1.5" Rear Blocks x2

Torsion Keys x2

1959BAG6:

14mm-2.0 x 110mm Hex Head Bolts x4

14mm-2.0 Nylock Nuts x4

14mm Flat Washers x4

1/2" Aluminum Diff Spacers x4

1958BAG1:

Shock Spacers x4

3/8-16 x 1.5 Hex Head Bolt x4

3/8-16 x 1-1/4 Hex Head Bolt x2

3/8" Flat Washers x8

3/8" Lock Washer x6

3/8-16 Hex Nut x6

7/16-14 x 1-3/4 Hex Head Bolt x4

7/16" Flat Washers x4

7/16-14 Top Lock Nut x4

1958BAG:

Instructions

Shock Decals x4

Warning to Driver Decal x1

Service Reminder x1

1959BAG9:

Torsion Key Retainers x2

5/8BAG:

5/8" Washers x8

5/8" Lock Nuts x8



INSTALLATION INSTRUCTIONS

1. Using a jack raise up the front of the vehicle. Place jack stands under the frame rails and lower onto jack stands letting the front suspension hang.
2. Using a 22mm socket remove the wheels and tires from the vehicle.
3. Use the torsion bar tool SKU: 1067. For the 3 next steps to remove the torsion key.
4. Take a measurement of the load bolt from the bottom of the bolt head to the bottom of the torsion bar crossmember. Record measurement here _____. This will be set as a starting point when the vehicle is reassembled. Use a 21mm socket to remove the bolt. Retain hardware for reuse. **See Photo 1.**
5. Install the torsion bar tool onto the crossmember, place the adapter pin into the location hole over the key and seat the U-bolt portion of the tool into the adapter. Install the cross bar and nuts then snug to the cross member. Using a 21mm socket tighten the tool raising up the key to give clearance to remove the threaded block. **See Photo 2.**

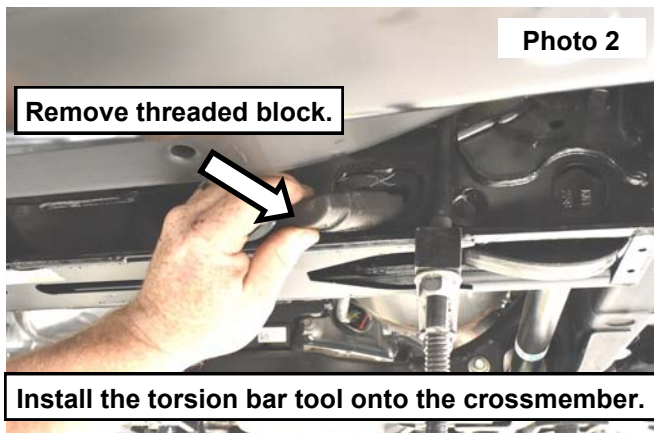
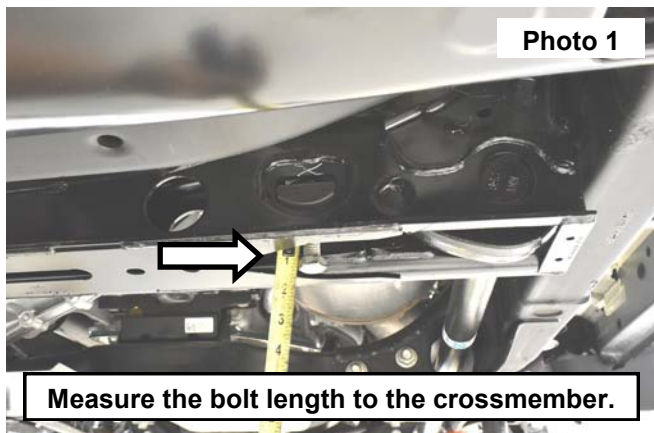

6. Remove tool from the vehicle, support the key sliding the torsion bar forward and removing the key. **See Photo 3.**
7. Repeat steps 4-6 to remove the opposite side key.
8. Using a 21mm socket loosen the nut on the tie rod end, using a hammer unseat the taper on the ball joint, remove nut. Retain for reuse. **See Photo 4.**

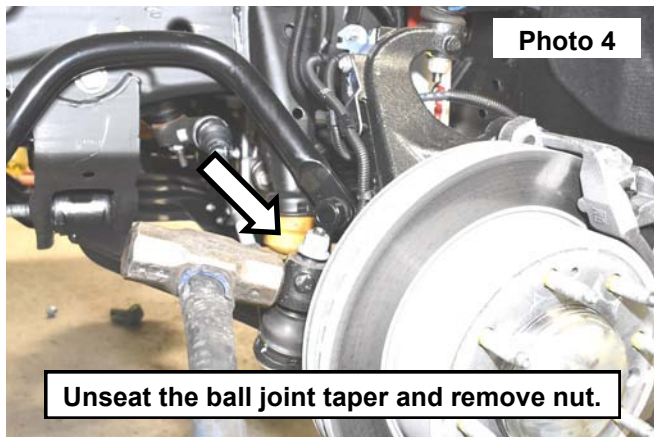
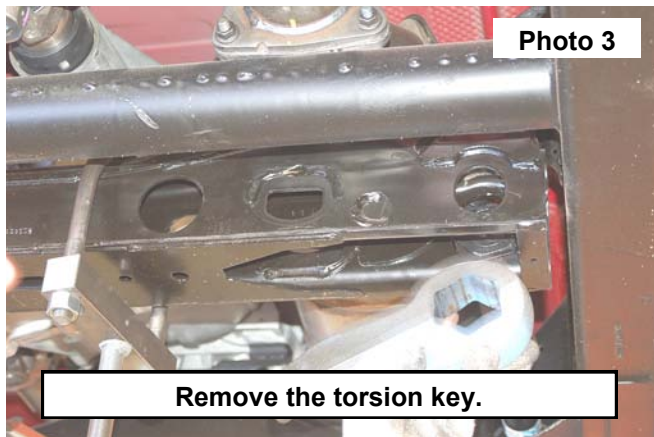

9. Remove the bolt in the brake line from the frame mount using a 13mm socket. Retain for reuse. **See Photo 5.**
10. Loosen the upper control arm nut, use an 18mm wrench. Do not remove nut. **See Photo 6.**

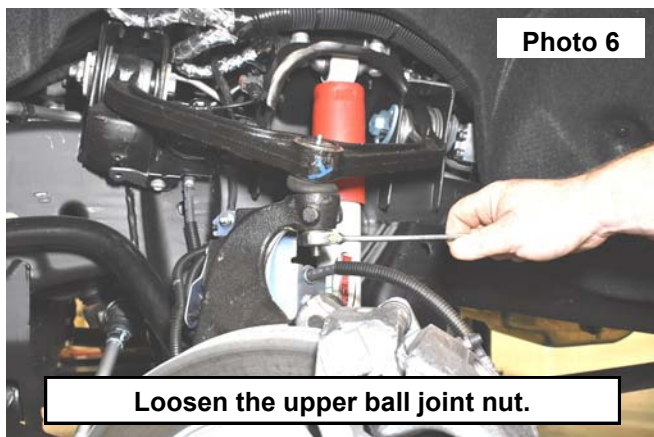
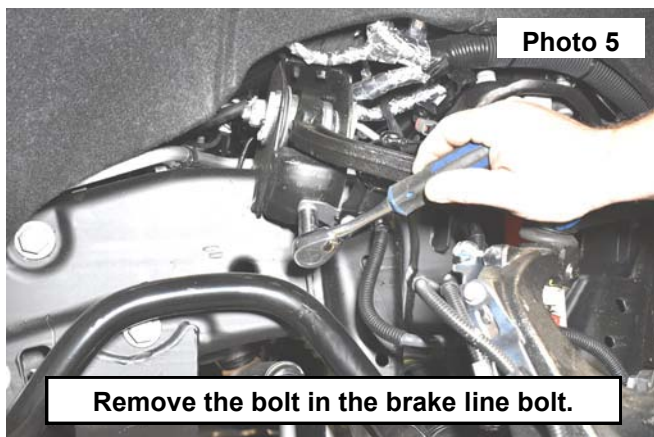

11. Support the lower control arm. Using a hammer, strike the knuckle to unseat the taper. **See Photo 7.**
12. Remove the upper ball joint nut, letting the knuckle relax in the forward position. **▲ NOTICE** Do not over extend the CVs on the axle.
13. Using a 21mm wrench and socket remove the lower shock bolt. Retain for reuse. **See Photo 8.**

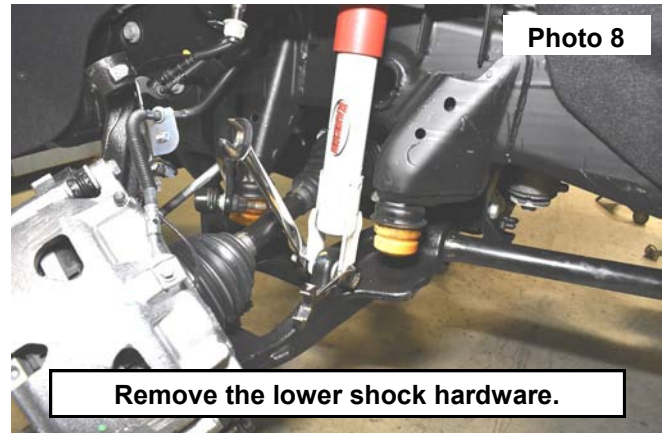
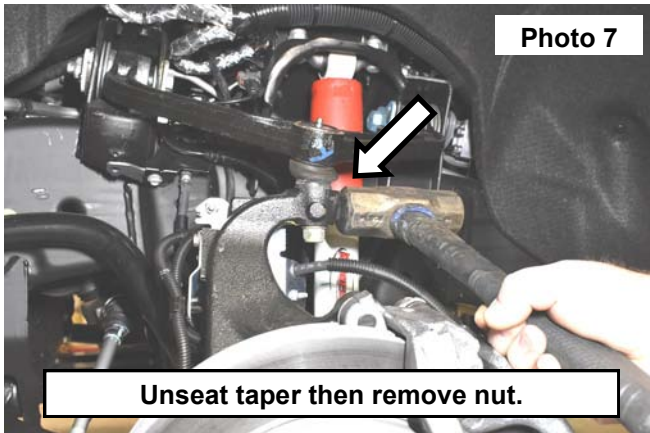

14. Remove the wiring harness from upper shock mount and remove the (2) nuts using a 21mm wrench. Then remove the shock. **See Photo 9.**
15. Using a 24mm wrench remove upper control arm cam bolts. Retain for reuse. **See Photo 10.**
16. Remove control arm.

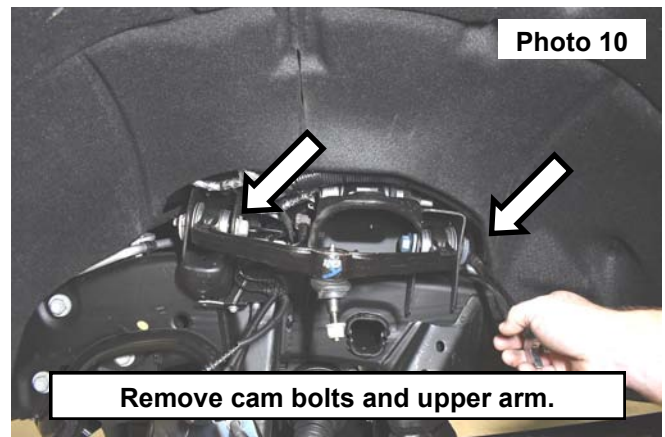
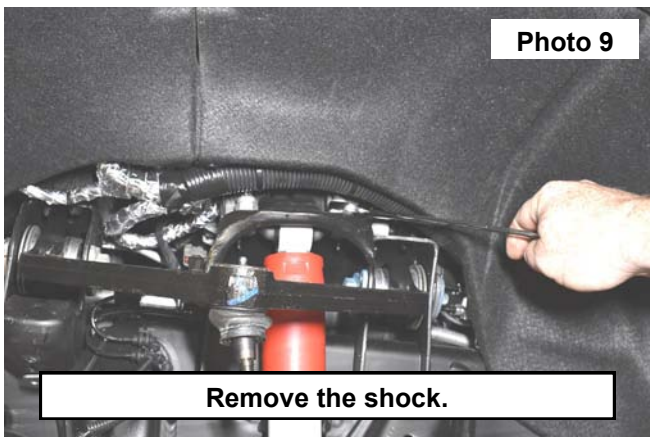

17. Identify the driver and passenger upper control arm. **A.** Remove and set aside the RC cap on top of the ball joint. **B.** Locate the ball joint alignment mark in the housing to determine application. **See Photo 11.**
18. Install the new upper control arm using the retained cam bolts. Set the cam bolts to the middle of the adjustment and only snug the nuts. **See Photo 12. Note:** *The upper arm will be tightened in a later step.*

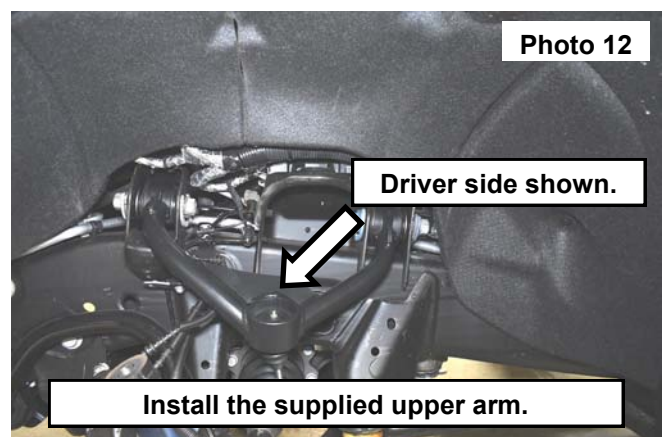
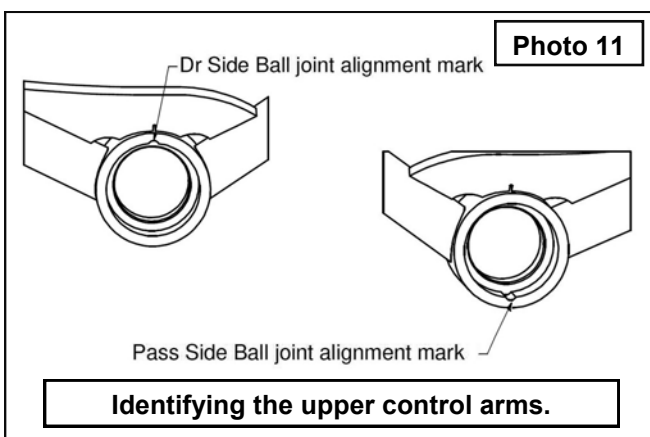

19. Locate shock number 660795 and install the supplied 7/16 hardware into the bar pin holes. Then install the (2) supplied spacers onto the bolts. **See Photo 13.**
20. Install the shock with the installed spacers into the shock mount on the vehicle. Tighten using a 5/8 wrench and socket. **See Photo 14.**

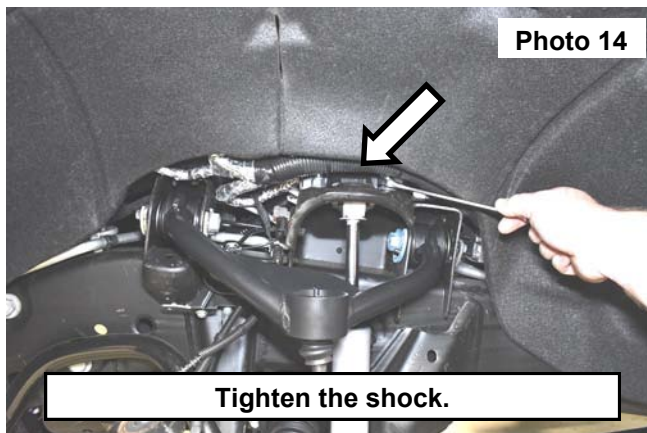
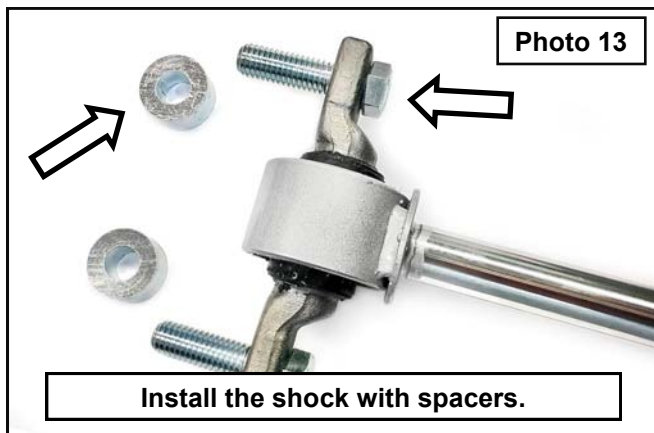

21. Install the lower shock mount onto the lower control arm, secure using the retained hardware. **Note: The lower shock will be tightened in a later step. See Photo 15.**
22. Connect the upper ball joint to the knuckle, seat the taper tightening the nut using a 18mm wrench. **See Photo 16.**

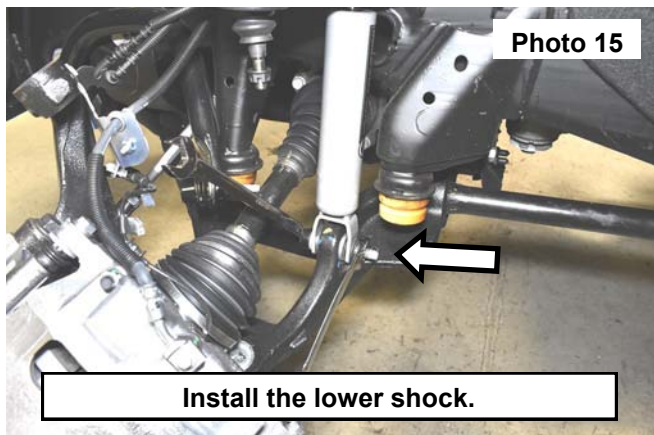

23. Using the retained hardware install the brake line bracket onto the frame in the OE location. Tighten using a 13mm wrench. **See Photo 17.**
24. Grease the upper ball joint and install the RC cap. **See Photo 18.**
25. Repeat steps 8-24 on the opposite side of the vehicle.

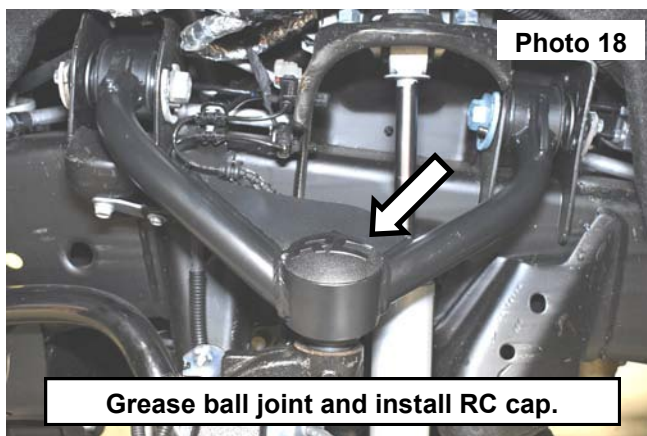
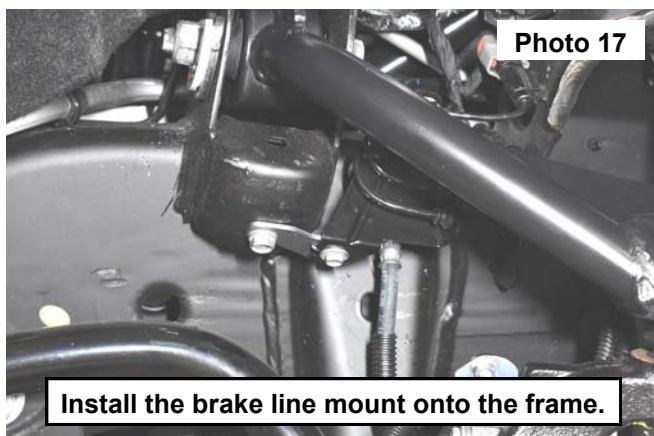

26. Connect the tie-rod end to the knuckle using 21mm socket on both sides of the vehicle. **See Photo 19.**
27. Remove the 4 bolts from the skid plate and remove from the vehicle. **See Photo 20.** Retain hardware for reuse.

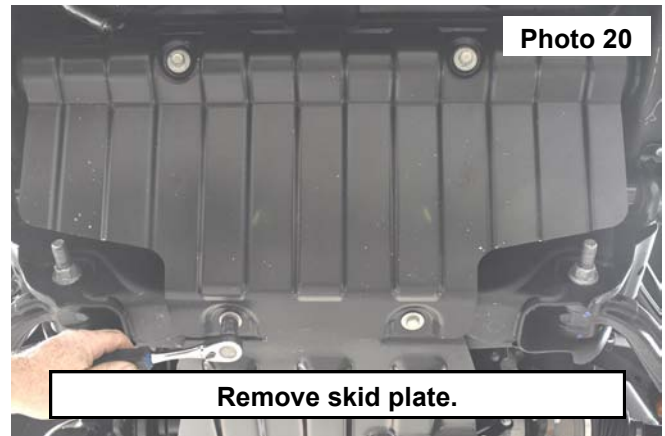
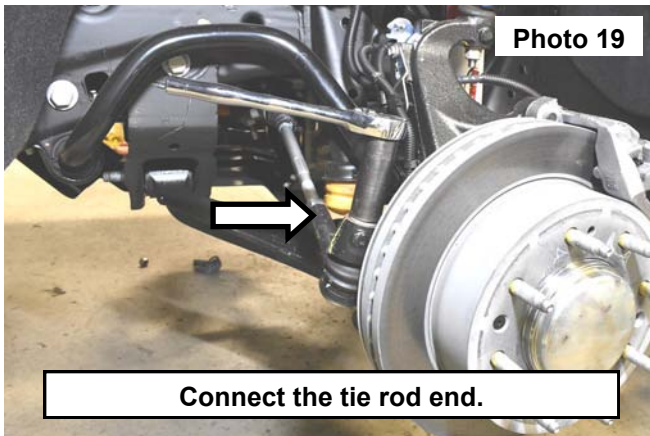

28. Remove the 2 bolts in the sway bar mount on each side of the sway bar using a 10mm socket. Retain hardware for reuse. **See Photo 21.**
29. Install the (2) 3/8-16 x 1.5 hex head bolts into the sway bar relocation bracket. Install the brackets onto each side of the frame using the retained OE hardware. Tighten using a 10mm socket. **See Photo 22.**

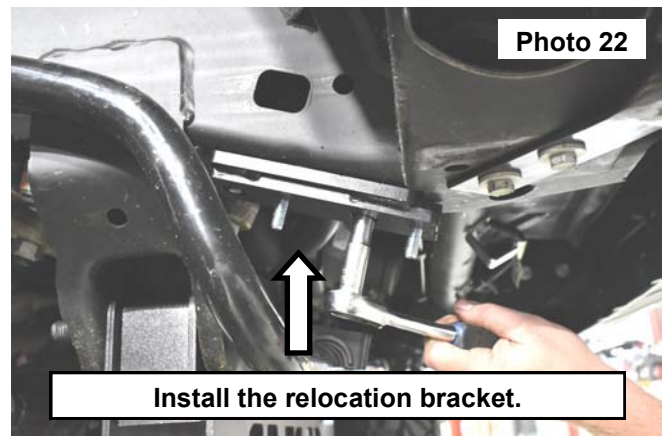
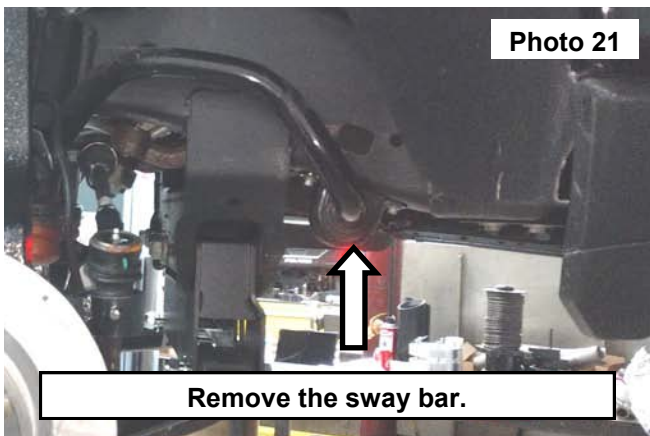

30. Install the sway bar onto the relocation bracket, secure using (2) of the supplied 3/8" flat washers and (2) 3/8-16 hex nuts on each side. Tighten using a 9/16 socket. **See Photo 23.**
31. Using a 21mm socket. Remove the front 2 diff mounting bolts. Install supplied diff spacers between diff mount and frame. Secure using the supplied 14mm x 130mm bolt nut and washers. Tighten to factory specs using a 22mm. **See Photo 24.**

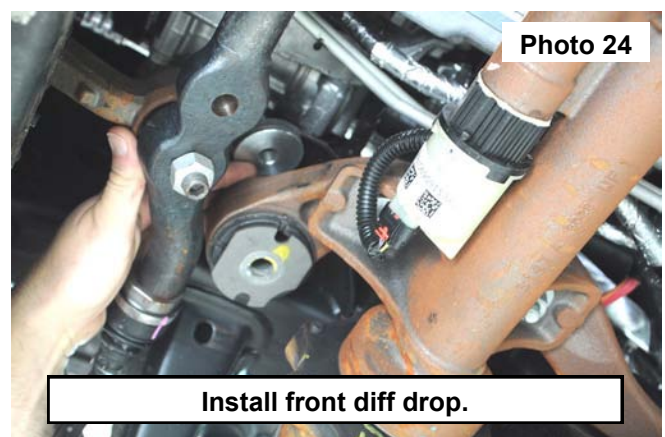
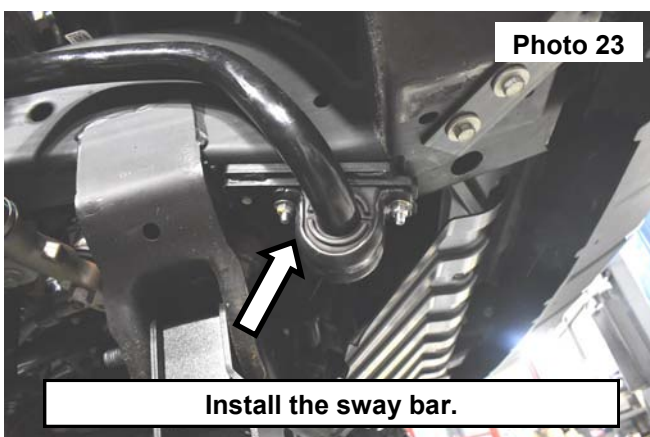

32. Using a 21mm socket. Remove the rear 2 diff mounting bolts. Install supplied diff spacers between diff mount and frame. Secure using the supplied 14mm x 130mm bolt nut and washers. Tighten to factory specs using a 22mm. **See Photo 25.**
33. Install the 2 skid plate brackets onto the upper mount using the retained hardware. **See Photo 26.**
34. Install the skid plate using (2) of the supplied 3/8-16 x 1-1/4 hex head bolts, (2) 3/8" Large USS washers, (1) 3/8 lock washer and (1) 3/8-16 nut on each side. **See Photos 26 and 27.**

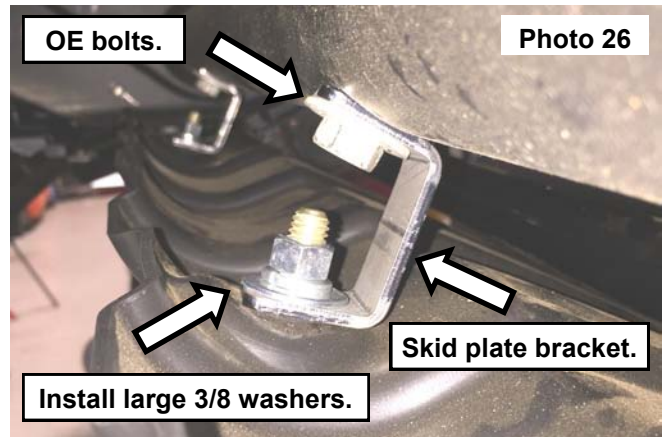

35. Install the retained OE skid plate bolts on the lower mount. Tighten the OE hardware using a 15mm wrench or socket. Tighten the 3/8" hardware using a 9/16 wrench and socket. **See Photo 28.**

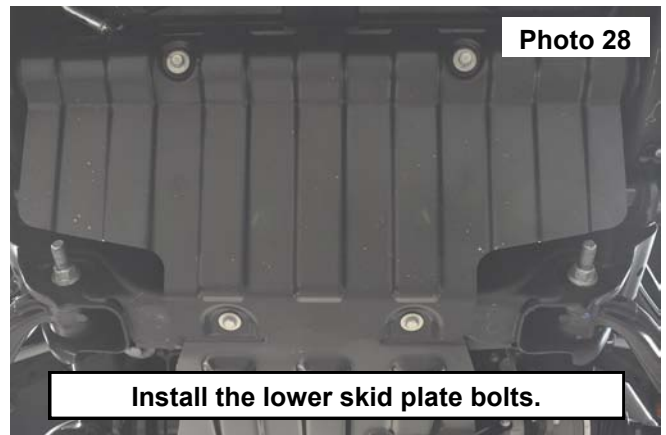
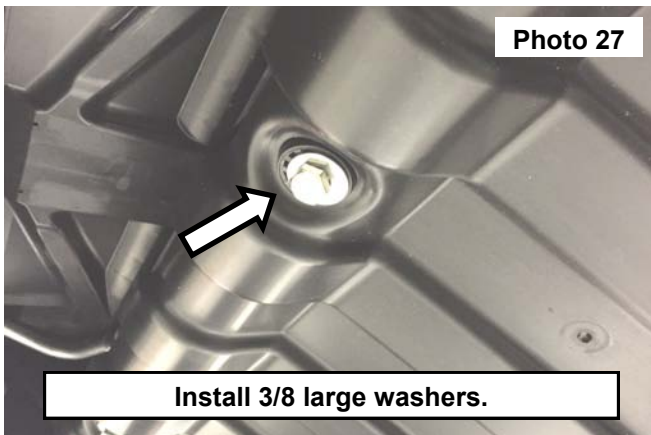

36. Install the supplied torsion key bolt retainer on the torsion key. **See Photos 29 and 30.**

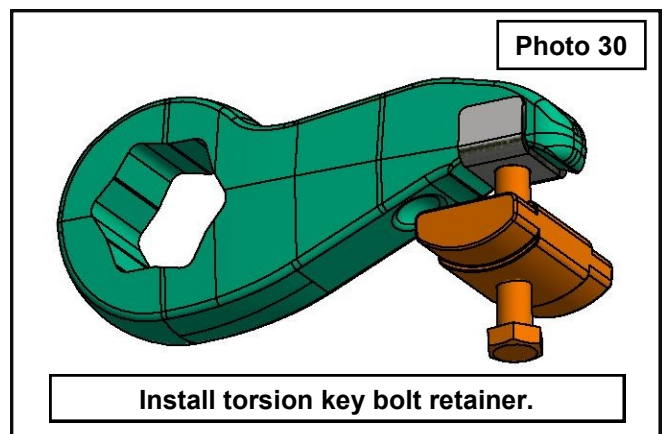
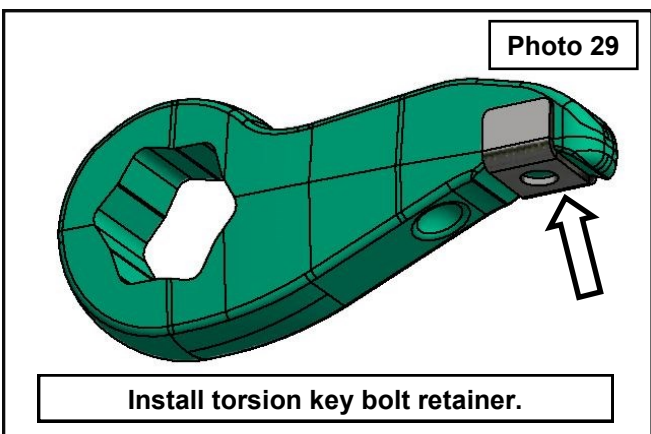

37. Install the supplied key and bolt retainer, use the torsion bar tool to give clearance to install the threaded block. **See Photo 31.**
38. Install the bolt into the threaded block and set the starting ride height to the recorded measurement in step 4 using a 21mm socket. **See Photo 32.**

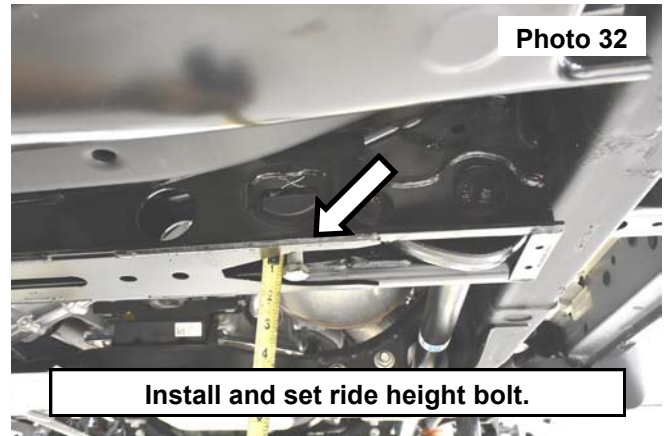
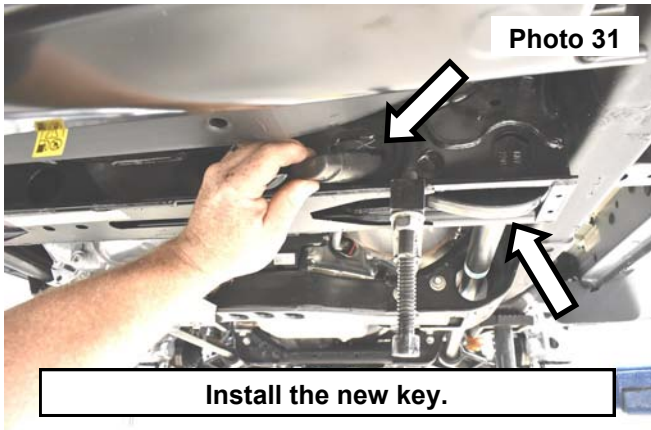

39. Install the wheels and tires.
40. Using a jack raise up the front of the vehicle then remove the jack stands and set on the ground.
41. Tighten the lower shock using a 21mm wrench and socket.
42. Tighten the upper control arms using a 24mm wrench.
43. This vehicle will need an alignment preformed.
44. Check the front ride height, if adjustments needed use the jack to raise the vehicle and support with a jack stand before the bolt is adjusted.

REAR INSTALLATION

1. Chock the front wheels.
2. Place a floor jack under the differential and jack up the rear of the vehicle.
3. Place jack stands under the frame rails and lower onto the jack stands.
4. Remove the tires/wheels.
5. Remove the factory shock absorbers using a 21mm wrench & socket. Retain the factory hardware for reuse.
6. Remove the factory u-bolts using a 21mm socket, then remove the factory blocks. Lower the axle using the floor jack to allow for the new 1.5" block to be installed.
7. Install the block on the factory spring pad, **▲ NOTICE** The center pin should be installed offset to the front of the vehicle. Jack up the axle to meet the springs, making sure to align the center pin. **See Photos 1 & 2**

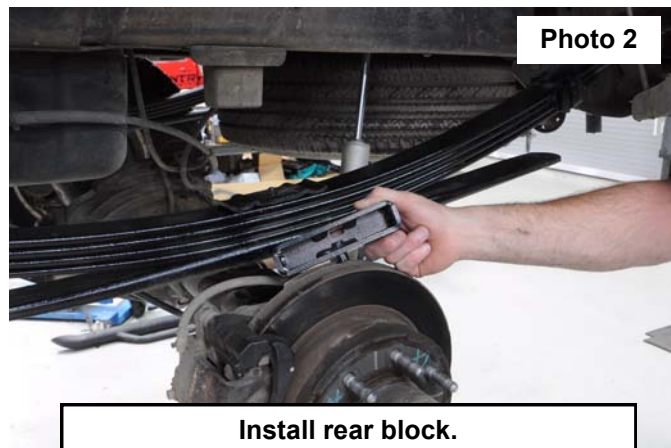
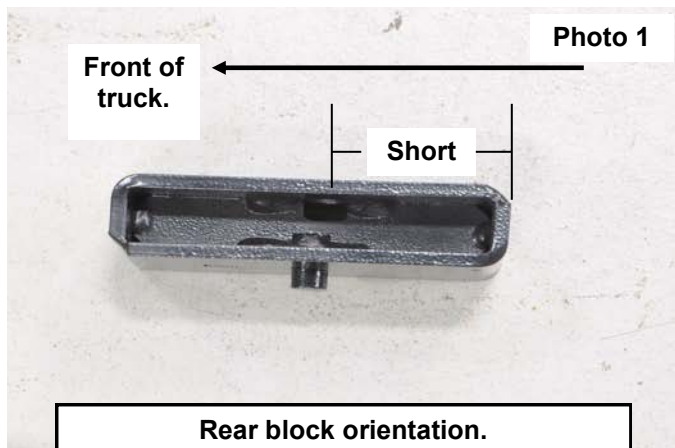

8. With the floor jack applying slight pressure to the rear axle to keep the pin aligned, install the new supplied u-bolts and tighten in a crossing pattern, using a 7/8" socket. **See Photo 3.**
9. Locate the new shock absorbers (660744), and install the shock absorbers in the factory mounting locations using the factory hardware. Tighten using a 21mm wrench & socket. **See Photo 4.**

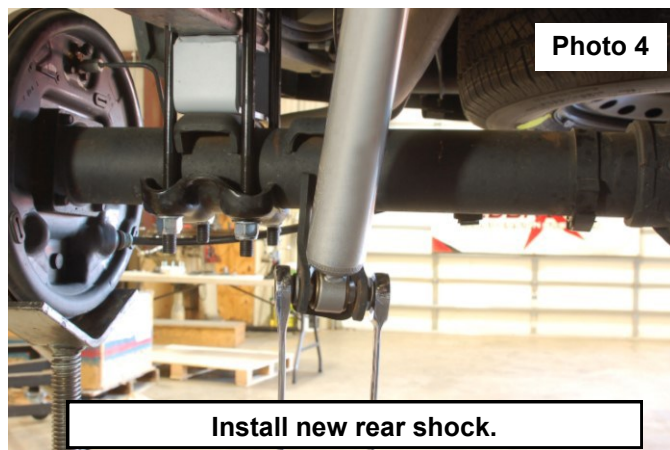

10. Install the tires/wheels.
11. Jack up the vehicle to remove the jack stands. Remove the jack stands and lower the vehicle to the ground.

POST INSTALLATION INSTRUCTIONS

1. Have a qualified alignment center align the vehicle, to factory specs, immediately.
2. Have headlights adjusted to proper settings.
3. Wheels must be retightened at 50 miles.
4. All kit components must be retightened at 500 miles and then every three thousand miles after installation. Periodically check hardware for tightness.
5. Install "Warning to Driver" decal on sun visor.
6. On some vehicles the front lower skirting will need to be trimmed if using certain wheel /tire combinations and with heavy offset wheels. Trim only as needed.



By purchasing any item sold by Rough Country, LLC, the buyer expressly warrants that he/she is in compliance with all applicable, State, and Local laws and regulations regarding the purchase, ownership, and use of the item. It shall be the buyers responsibility to comply with all Federal, State and Local laws governing the sales of any items listed, illustrated or sold. The buyer expressly agrees to indemnify and hold harmless Rough Country, LLC for all claims resulting directly or indirectly from the purchase, ownership, or use of the items.

