

ROUGH COUNTRY

SUSPENSION SYSTEMS®

RAM 2019-UP 1500 5.7L PERFORMANCE CAT-BACK EXHAUST

Fits 5.7L Engine / 140.5", 144.6" & 153.5" Wheelbase / Crew Cab & Extended Cab (5'7" & 6'4" Beds)

Thank you for choosing Rough Country for all your vehicle needs.

Please read instructions before beginning installation. Check the kit hardware against the kit contents shown below. Be sure you have all needed parts and know where they go.

If question exist, please call us @1-800-222-7023. We will be happy to answer any questions concerning this product. Check all fasteners for proper torque. Check to ensure for adequate clearance between all components. Periodically check all hardware for tightness.

See info below for proper fit for certain wheelbase and trimming dimensions

For 154" Wheelbase Crew Cab 6'4" Bed Vehicle: No Cutting Required

For 145" Wheelbase Crew Cab 5'7" Bed Vehicle: Trim 9" from Pipe (B)

For 141" Wheelbase Quad Cab 6'4" Bed Vehicle: Trim 13" from Pipe (B)

Allow adequate time for the exhaust to cool before disassembly.

KIT CONTENTS:

Inlet Tube (A)
 Mid Tube (B)
 Stainless Clamps x8
 Exhaust Flange x1
 Mid Tube Hanger Clamp (C)
 Rough Country Muffler (D)
 Left Side Pipe (E)
 Right Side Pipe (F)
 Left Side Mid Pipe (G)
 Right Side Mid Pipe (H)
 80 Degree Exit Tubes (I)
 Rear Exit Tubes (J)
 Rough Country Tips (K)

TOOLS NEEDED:

13mm Socket or Wrench
 15mm Wrench or Socket
 16mm Wrench or Socket
 Pry Bar
 Hammer
 Metal Cutting Saw

HARDWARE INCLUDED:

3/8" x 2" Bolts x2
 3/8" Flat Washers x2
 3/8" Lock Washers x2
 3/8" Nuts x2
 Poly Exhaust Hangers x2
 90 degree Hanger x2

Torque Specs:

Size	Grade 5	Grade 8	Size	Class 8.8	Class 10.9
5/16"	15 ft/lbs	20ft/lbs	6MM	5ft/lbs	9ft/lbs
3/8"	30 ft/lbs	35ft/lbs	8MM	18ft/lbs	23ft/lbs
7/16"	45 ft/lbs	60ft/lbs	10MM	32ft/lbs	45ft/lbs
1/2"	65 ft/lbs	90ft/lbs	12MM	55ft/lbs	75ft/lbs
9/16"	95 ft/lbs	130ft/lbs	14MM	85ft/lbs	120ft/lbs
5/8"	135ft/lbs	175ft/lbs	16MM	130ft/lbs	165ft/lbs
3/4"	185ft/lbs	280ft/lbs	18MM	170ft/lbs	240ft/lbs



INSTALLATION INSTRUCTIONS

1. Remove the Right and Left rear exhaust pipes at the joint using a 13mm socket. **See Photo 1.**
2. Loosen the clamp at the splitter above the axle using a 13mm socket. **See Photo 2.**

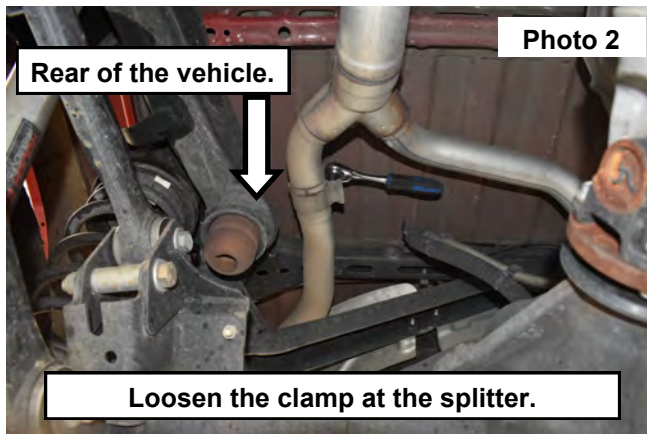

3. Remove the rubber hanger from the frame mount using a pry tool on each side of the vehicle. **See Photo 3.**
4. Remove the right rear exhaust tube. **See Photo 4.**

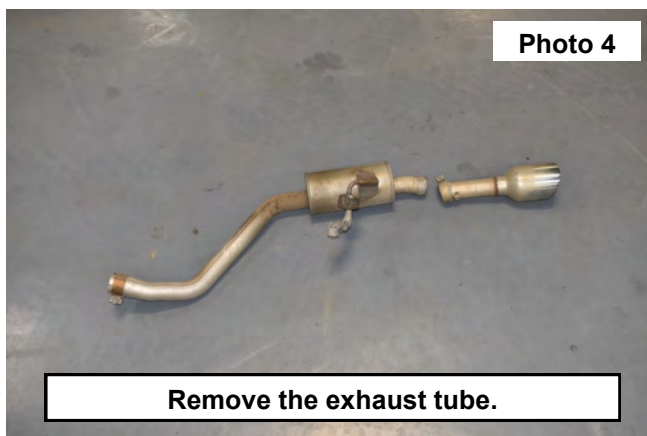

5. Remove the ground strap from the frame and the exhaust. Then use a pry tool to remove the rubber mount from the frame. **See Photo 5.**
6. Using a 16mm socket remove bolts from the flange at front of muffler. **See Photo 6.**

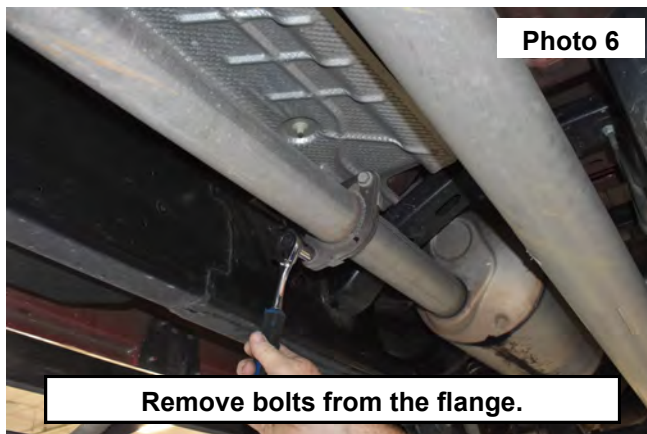
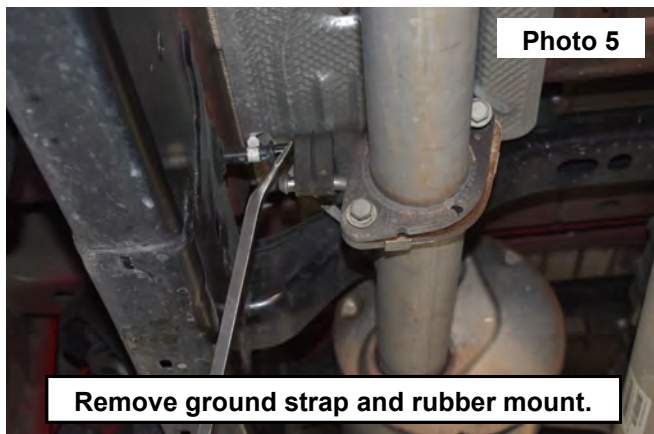

7. Locate the center muffler mount on the frame over the muffler. **See Photo 7.**
8. Support the muffler. Then remove the (2) nuts in the center mount using a 13mm socket. **See Photo 8.**



9. Remove the exhaust from the vehicle. **See Photo 9.**
10. Using a 15mm remove nuts from the converter flange above transmission cross-member. **See Photo 10.**
11. Remove the exit tube.

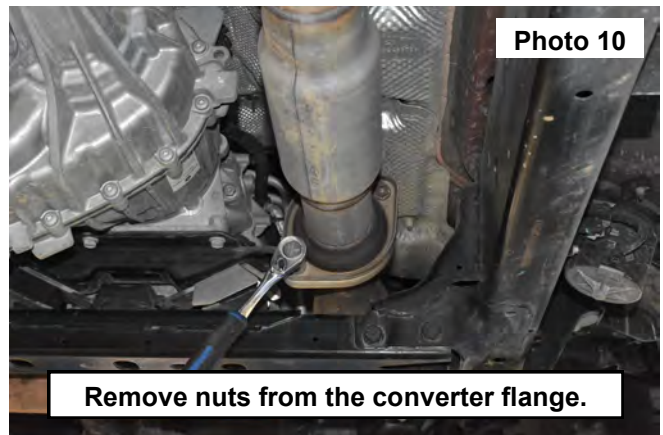
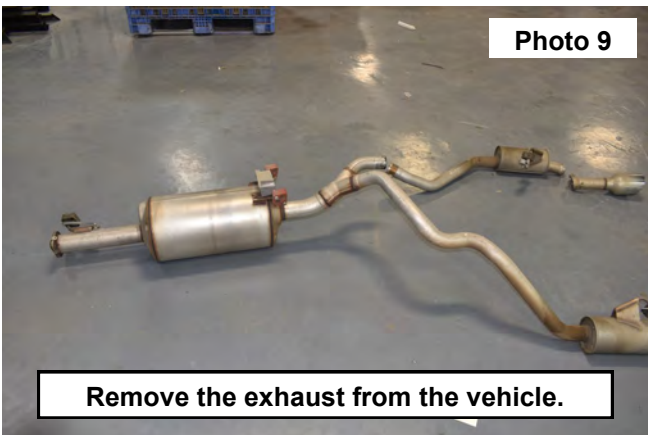

12. Use a air hammer to remove the (2) studs from converter flange. **See Photo 11.**
13. Place the flange onto the exit tube. **See Photo 12.**

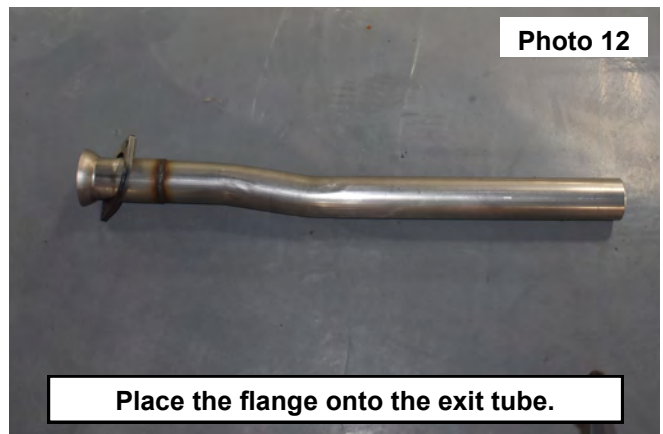
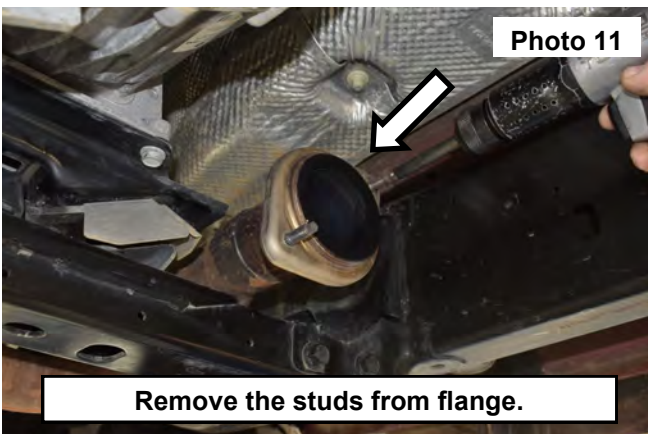

14. Install the exit tube onto the converter flange and secure using (2) of the supplied 3/8" bolts, (2) 3/8" flat washers and (2) 3/8" lock washers and (2) 3/8" nuts. **See Photo 13.**
15. Install the tube hanger clamp onto the mid tube. **See Photo 14. NOTE: For different chassis wheel base the Mid tube (B) will need to be trimmed to length.**
16. Refer to the 1st page of the instruction sheet for reference. If needed, trim remove the (B) pipe tube.

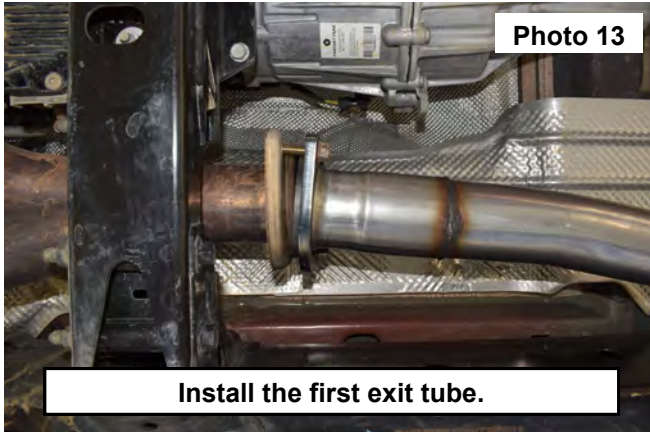

17. Then install the mid tube (B) onto the front exit tube (A). Then install the tube mount to the rubber frame mount. **See Photos 15.** Snug the tube clamp using a 15mm socket.
18. Support and Install the muffler onto the exit tube using (1) clamp. **See Photo 16.** Snug the tube clamp using a 15mm socket.

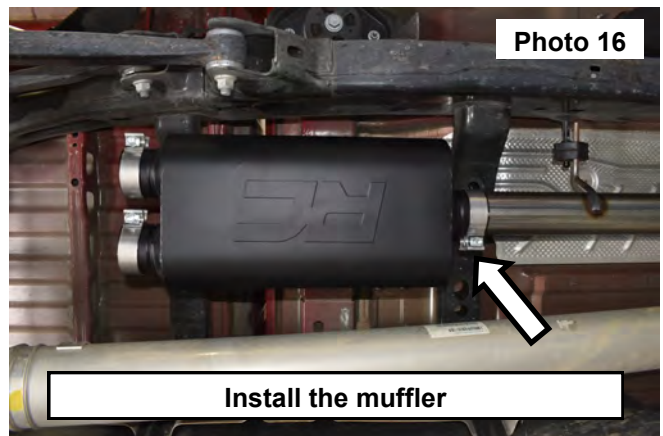
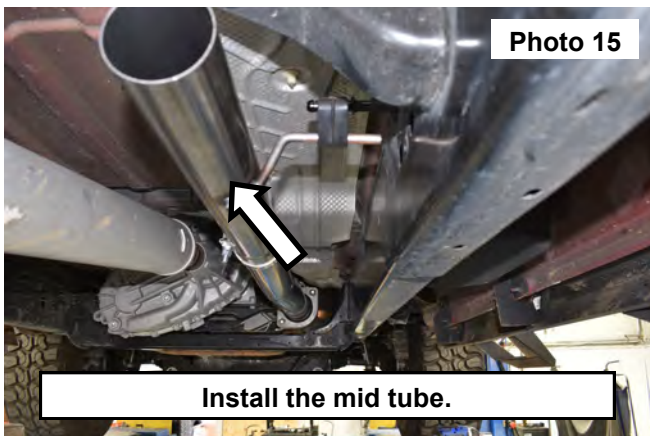

19. Install (2) clamps onto the exit flange of the muffler, then install the right and left exit tube into the muffler. **See Photo 17.**
20. Remove the rubber hanger bracket from the muffler. **See Photo 18.**

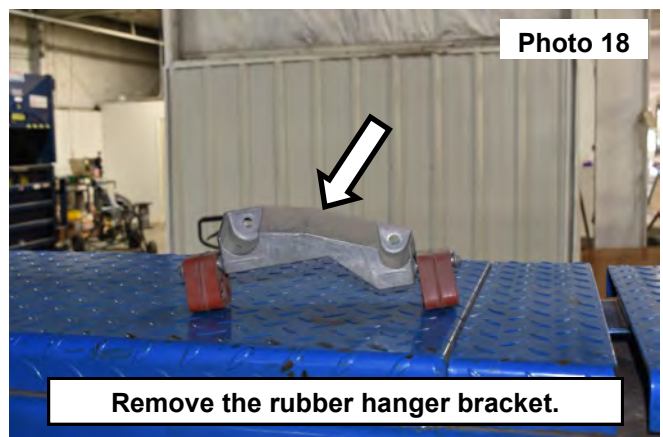
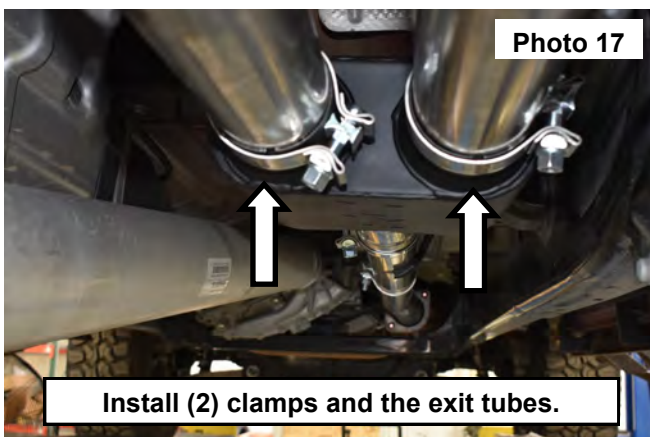

21. Install the OE rubber hanger bracket onto the rear right and left tube hangers. **See Photo 19.**
22. Place the hanger onto the frame studs, secure by using the (2) retained nuts. Tighten using a 13mm socket. **See Photo 20.**



23. Install (1) of the supplied rubber hangers onto the rear frame mount on the driver and passenger side of the vehicle. **See Photo 21.**
24. Install (1) of the supplied clamps on to the rear of the down tube. Then install the supplied exit tube and snug the clamp using a 15mm socket. **See Photo 22.**

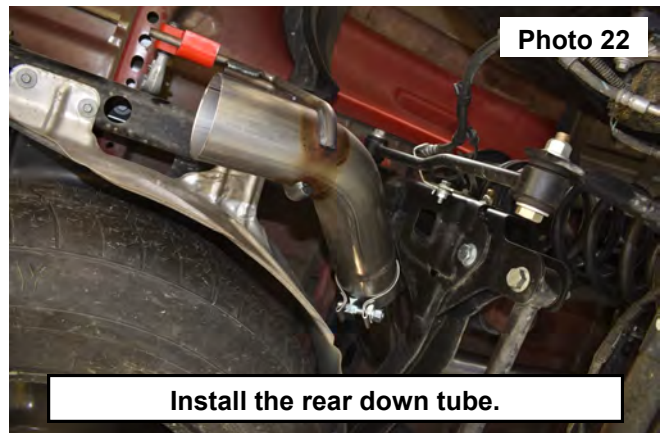
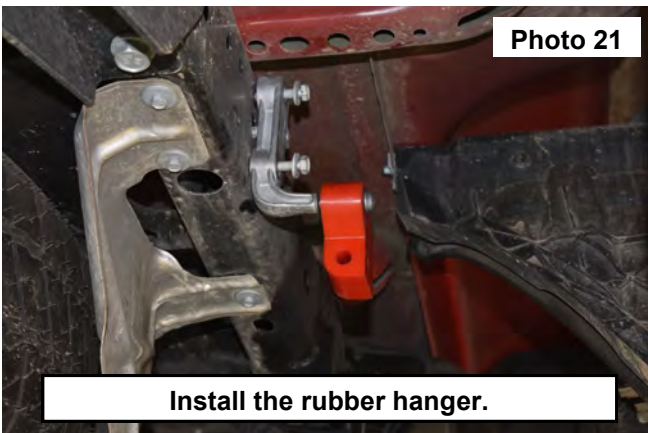

25. Install the exit tube into the rubber frame mount. **See Photo 23.**
26. Install (1) of the supplied clamps on to the down tube. Install the exit tube into the down tube then into the rubber frame mount. **See Photo 24.**

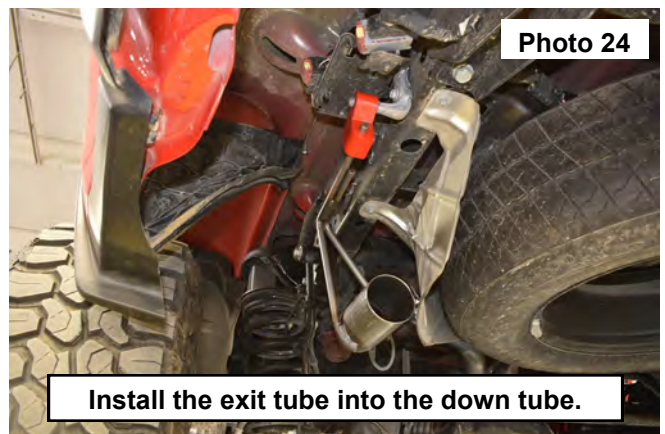
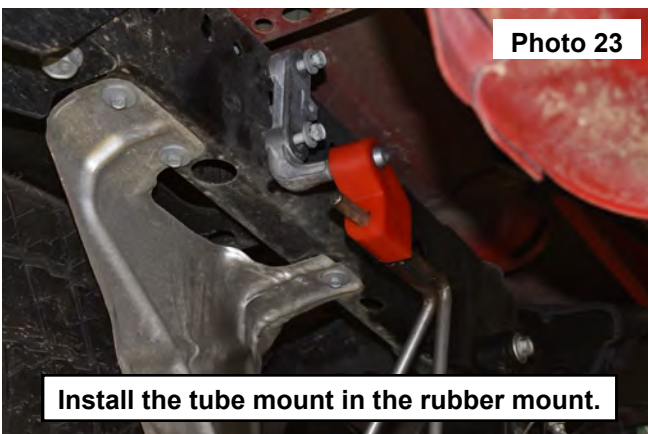

27. Install the side or rear exit tube using (1) of the supplied clamps. **See Photo 25.**
28. Install the rear exhaust tip, adjust out the tubes leaving clearance in-between the bumper and the tip. Tighten using a 10mm socket. **See Photo 26.**

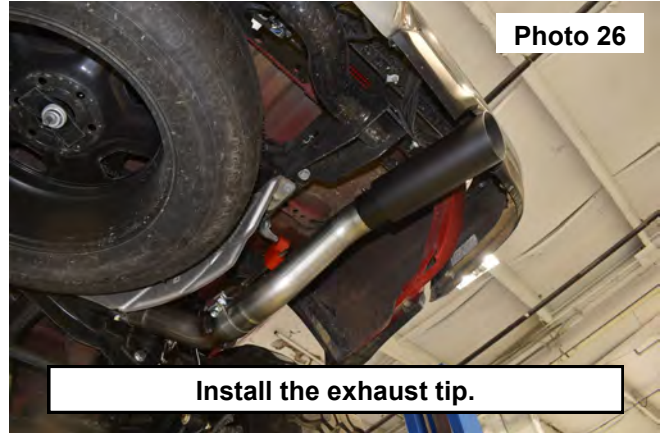
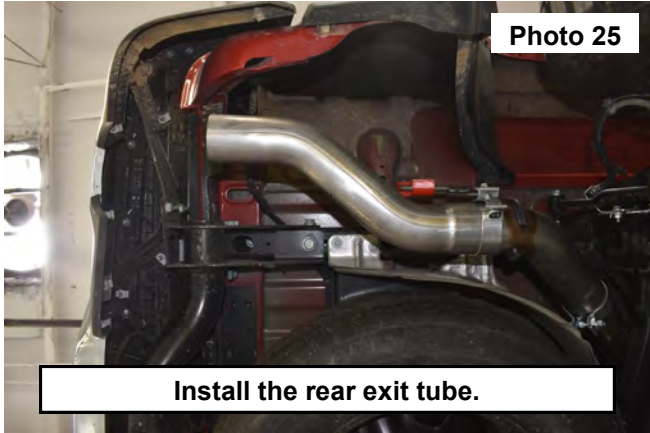

29. Tighten the converter flange bolts using a 16mm wrench and socket. **See Photo 27.**
30. Adjust the tubes and the muffler to the desired look and fitment under the vehicle. Tighten all of the clamps using a 15mm socket. Install the ground strap to the frame mount and the tube mount. **See Photo 28.**

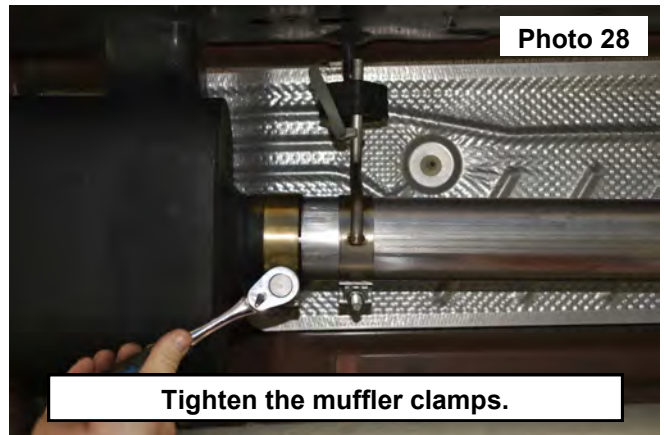
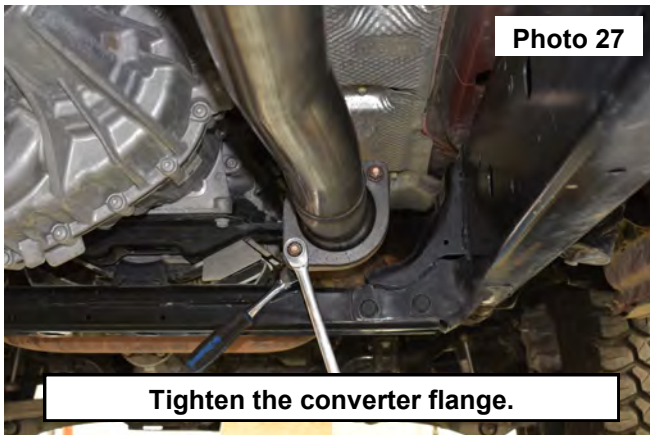

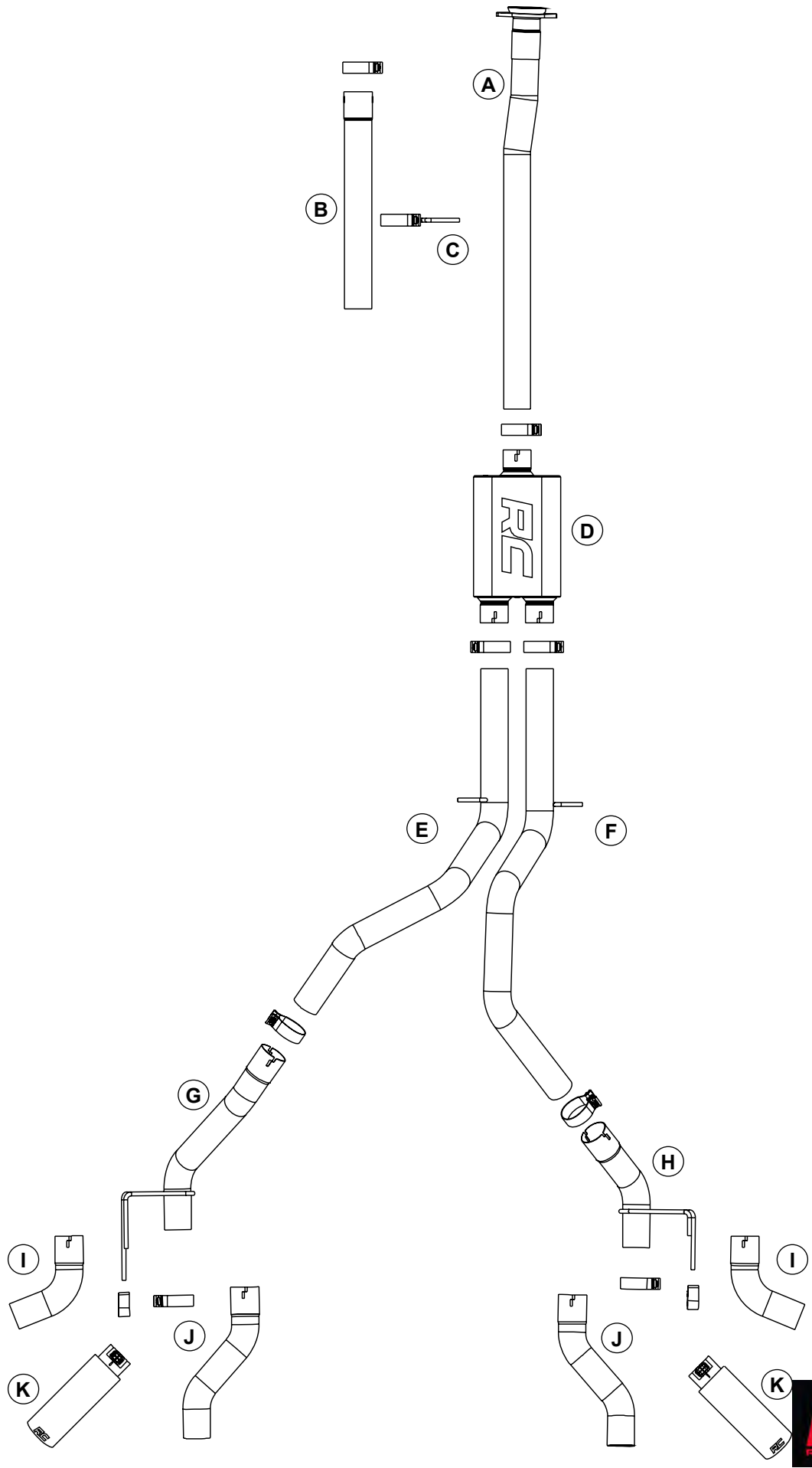

By purchasing any item sold by Rough Country, LLC, the buyer expressly warrants that he/she is in compliance with all applicable, State, and Local laws and regulations regarding the purchase, ownership, and use of the item. It shall be the buyers responsibility to comply with all Federal, State and Local laws governing the sales of any items listed, illustrated or sold. The buyer expressly agrees to indemnify and hold harmless Rough Country, LLC for all claims resulting directly or indirectly from the purchase, ownership, or use of the items.

